

Figure 2



QUOTE / ORDER INFORMATION

Photocopy this page and fill in the appropriate information for each project. Fax to your Dayton Superior Paving Products Dealer or to Dayton Superior Paving Products (formerly American Highway Technology).

Figure 3

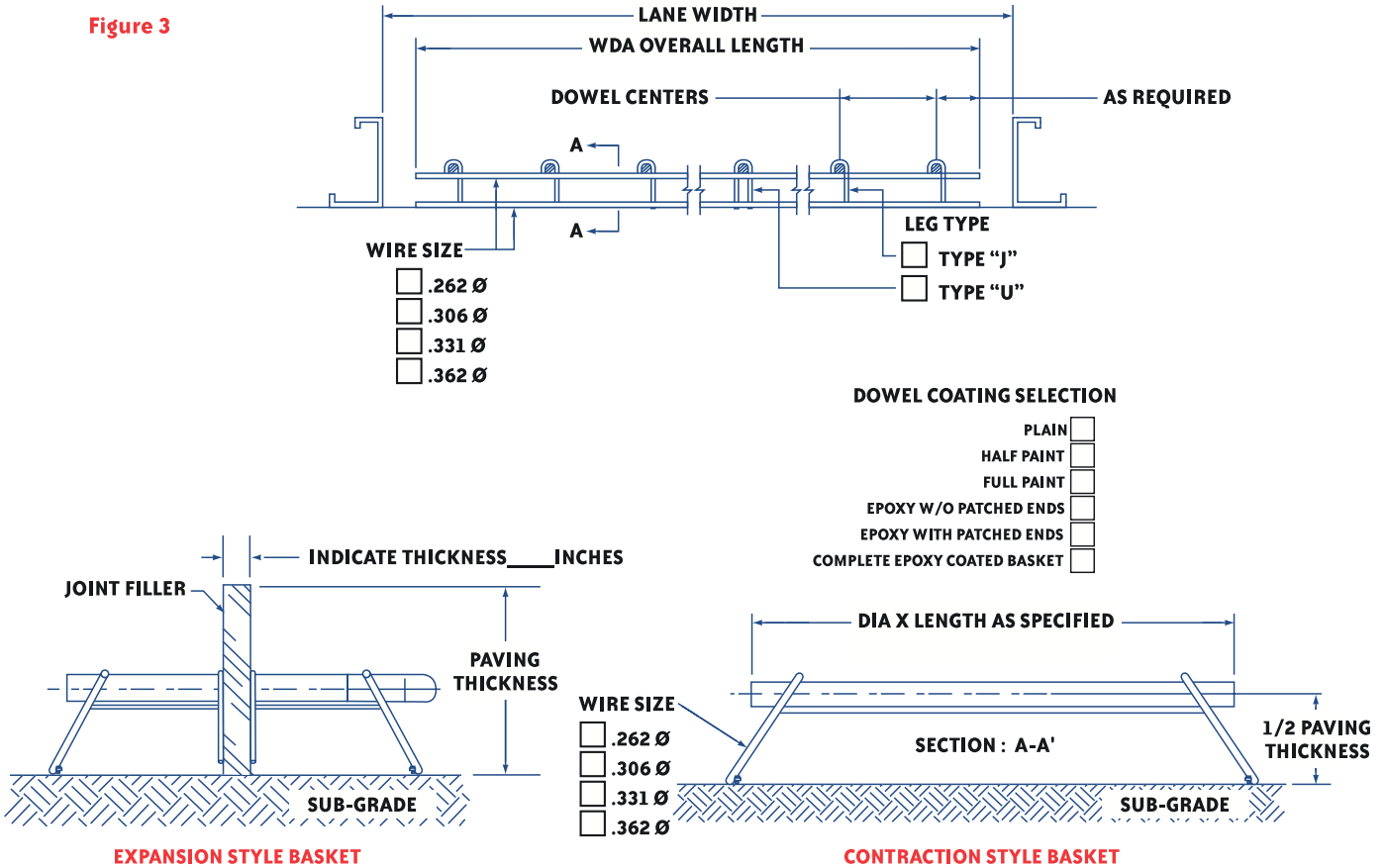

Pieces or Lineal Feet	Lane Width	Dowel Diameter	Dowel Length	Dowel Centers	Dowels Per Unit	Paving Thickness	Billable Length	Shop Applied Bondbreaker

Billable Length = Number of Dowels x Center

Date _____ Contact Person Requesting Information _____

Company _____ Project Name _____ Location _____



Load Transfer Products

Welded Dowel Assemblies

*EP DWL = Epoxy Dowels,
 EP DWL/PE = Epoxy Dowels with Patched Ends
 FULL PAINT = Fully Painted
 FULL EP = Complete Epoxy Coating
 TE = Complete Tectyl-506 Coating

Product Codes by State

State	Pavement Depth (in inches) / Part Number									Diameter of Dowel	Length of Dowel	O/C	Coating	Lb./Ft.
	6	8	9	10	11	12	13	14	18					
AL								AL14		1 1/2	18	12	EP DWL/TE*	10.59
AR	AR6		AR9	AR10	AR11	AR12				3/4	18	12	FULL PAINT*	3.59
										1 1/4	18	12	FULL PAINT	7.72
										1 1/4	18	12	FULL PAINT	7.82
										1 1/2	18	12	FULL PAINT	10.69
AZ			AZ9							1 1/4	18	12	EP DWL/PE	7.77
CA		CA8	CA9	CA10	CA11	CA12				1 1/4	18	12	FULL EP*	7.77
										1 1/2	18	12	FULL EP	10.65
CO	CO6	CO8	CO9	CO10	CO11	CO12	CO13	CO14		3/4	18	12	EP DWL	3.59
										1	18	12	EP DWL	5.45
										1 1/4	18	12	EP DWL	7.72
										1 1/2	18	12	EP DWL	10.76
CT			CT9							1 1/8	18	12	EP DWL/TE	6.57
DE		DE8	DE9							1 1/4	18	12	EP DWL/TE	7.73
										1 1/4	18	12	EP DWL	7.77
GA	GA6	GA8		GA10						1 1/8	18	12	EP DWL	6.53
										1 1/4	18	12	EP DWL	7.72
IA		IA8	IA9	IA10	IA11 (IA280)	IA12 (IA305)				1 1/4	18	12	EP DWL/TE	7.77
										1 1/2	18	12	EP DWL/TE	10.59
										1 1/2	18	12	EP DWL/TE	10.70
										(35mm)	(450mm)	12	EP DWL/PE	9.50
										1 1/2	18	12	EP DWL/TE	10.80
										(38mm)	(450mm)	12	EP DWL/TE	10.80
ID						ID12				1 3/4	18	12	EP DWL/TE	14.00
IL	IL6	IL8	IL9	IL10	IL11	IL12				1	18	12	EP DWL	5.30
										1 1/2	18	12	EP DWL	10.62
IN		IN8	IN9	IN10	IN11	IN12		IN14		1 1/4	18	12	EP DWL	7.90
										1 1/2	18	12	EP DWL	10.768
KS		KS8	KS9	KS10	KS11	KS12				1	18	12	EP DWL/TE	5.46
										1 1/8	18	12	EP DWL/TE	6.58
										1 1/4	18	12	EP DWL/TE	7.87
										1 3/8	18	12	EP DWL/TE	9.19
										1 1/2	18	12	EP DWL/TE	10.69
KY						KY12				1 1/2	18	12	EP DWL/TE	10.76
LA	LA6	LA8			LA11					1	18	12	EP DWL	5.37
										1 1/8	18	12	EP DWL	6.53
										1 1/2	18	12	EP DWL	10.64
MA				MA10						1 1/4	18	12	FULL EP	7.82

Load Transfer Products



Welded Dowel Assemblies continued

Product Codes by State, continued

State	Pavement Depth (in inches) / Part Number									Diameter of Dowel	Length of Dowel	O/C	Coating	Lb./Ft.
	6	8	9	10	11	12	13	14	18					
MD		MD8	MD9							1	18	12	EP DWL	5.45
				MD10							1 1/4	18	12	EP DWL
											1 1/4	18	12	EP DWL/TE
ME						ME12				1 1/2	18	12	TE	10.69
MI		MI8	MI9	MI10	MI11	MI12				1 1/4	18	12	EP DWL/TE	8.11
MN						MN12				3/4 1 1/2	15	12	EP DWL	3.86
								MN18			15	15	15	EP DWL
MO	MO6	MO8	MO9	MO10						1 1/4	18	12	EP DWL/TE	7.85
					MO11	MO12	MO13	MO14		1 1/2	18	12	EP DWL/TE	10.77
MT		MT8	MT9							1 1/4	18	12	EP DWL	7.72
				MT10						1 1/4	18	12	EP DWL	7.82
NC			NC9							1 1/8	18	12	EP DWL/TE	10.55
				NC10						1 1/4	18	12	EP DWL/TE	7.82
					NC11	NC12		NC14		1 1/2	18	12	EP DWL/TE	10.77
ND		ND8								1 1/4	18	12	EP DWL	7.73
				ND10	ND11		ND13			1 1/2	18	12	EP DWL	10.73
NE			NE9							1 1/4	18	12	EP DWL/TE	7.81
				NE10	NE11	NE12				1 1/2	18	12	EP DWL/TE	10.69
NM		NM8	NM9	NM10						1 1/4	18	12	EP DWL/PE	7.81
NV				NV10						1	18	12	EP DWL	5.54
					NV11					1 3/8	18	12	EP DWL	9.18
							NV13			1 1/2	18	12	EP DWL/TE	10.73
NY		NY8	NY9							1	18	12	EP DWL/TE	5.46
				NY10							1 1/8	18	12	EP DWL/TE
					NY11					1 1/4	18	12	EP DWL/TE	7.88
						NY12				1 3/8	18	12	EP DWL/TE	9.19
										1 1/2	18	12	EP DWL/TE	10.77
OH	OH6	OH8	OH9	OH10						1	18	12	FULL EP	5.49
					OH11	OH12	OH13	OH14		1 1/4	18	12	FULL EP	7.53
										1 1/2	18	12	FULL EP	10.77
OK		OK8	OK9	OK10	OK11					1 1/4	18	12	EP DWL	7.53
						OK12				1 1/2	18	12	EP DWL	10.68
PA	PA6									1	18	12	EP DWL/TE	5.59
		PA8	PA9	PA10						1 1/4	18	12	EP DWL/TE	8.08
					PA11	PA12	PA13			1 1/2	18	12	EP DWL/TE	11.39
SD		SD8	SD9	SD10	SD11					1 1/4	18	12	EP DWL/TE	7.87
TX	TX6	TX8	TX9							1	18	12	FULL PAINT	5.46
				TX10							1 1/8	18	12	FULL PAINT
					TX11					1 1/4	18	12	FULL PAINT	7.82
						TX12				1 3/8	18	12	FULL PAINT	9.19
										1 1/2	18	12	FULL PAINT	10.59
								TX13		1 5/8	18	12	FULL PAINT	12.30
UT				UT10	UT11	UT12	UT13	UT14		1 1/2	18	12	FULL EP	10.77

Load Transfer Products



Welded Dowel Assemblies continued

Product Codes by State, continued

State	Pavement Depth (in inches) / Part Number									Diameter of Dowel	Length of Dowel	O/C	Coating	Lb./Ft.
	6	8	9	10	11	12	13	14	18					
VA						VA12				1 1/2	18	12	TE	10.50
WA		WA8	WA9	WA10	WA11	WA12	WA13			1	18	12	EP DWL/PE	5.45
										1 1/4	18	12	EP DWL/PE	7.79
										1 1/2	18	12	EP DWL/PE	10.72
										1 1/2	18	12	EP DWL/PE	10.72
WI	WI6	WI8	WI9	WI10	WI11	WI12				3/4	18	12	EP DWL	3.50
										1 1/4	18	12	EP DWL/TE	7.63
										1 1/2	18	12	EP DWL/TE	10.48
WV	WV6		WV9	WV10	WV11	WV12				3/4	18	12	EP DWL	3.46
										1 1/4	18	12	EP DWL	10.59
										1 1/2	18	12	EP DWL	10.68
WY				WY10						1 1/2	18	12	EP DWL	10.59

Product Codes for Canada

Place	Pavement Depth (in inches) / Part Number									Diameter of Dowel	Length of Dowel	O/C	Coating	Lb./Ft.
	6	8	9	10	11	12	13	14	18					
Canada		CAN8	CAN9	CAN10	CAN11	CAN12				1 1/4	18	12	EP DWL/TE	7.91
Ontario		ON8	ON9	ON10	ON11	ON12				1 1/4	18	12	EP DWL/TE	7.85
Quebec					QB11 (QB275)	QB12 (QB310)				1 3/8 (35mm)	18 (450mm)	12	EP DWL/TE	9.50
					1 1/2 (38mm)					18 (450mm)	12	EP DWL/TE	9.75	

Product Codes for Airports

Place	Pavement Depth (in inches) / Part Number									Diameter of Dowel	Length of Dowel	O/C	Coating	Lb./Ft.								
	6	8	9	10	11	12	13	15	18													
Airport						AP12				1	19	12	VARY	5.02								
															AP15.1			1 1/4	20	15	VARY	8.10
															AP15.2			1 1/2	20	18	VARY	8.17
								AP18	1 1/2	20	18	VARY	10.30									

* Specification for Airports vary greatly by each project.

REMARKS

1. Pavement depths and Product codes not shown in this chart are also available from DS Paving Products.
2. Coating requirements may vary from job to job. For complete and accurate specifications, please refer to official DOT specifications of each state.
3. For the most up to date information, please refer to our website daytonsuperior.com
4. Welded Dowel Assemblies are priced on application.

Load Transfer Products



Wire Baskets (without Dowels)

Dowel Baskets without dowels are available for contraction and expansion joints in slabs 4" to 9" thick. These are fabricated for 3/4", 1", or 1-1/4" diameter dowels as required.

Type "D" Contraction Baskets and K-5 Type "D" Expansion Baskets are a standard 10" width.

Note: Dowel Bars, Dowel Caps, Basket Clips, and Basket Stakes are sold separately.

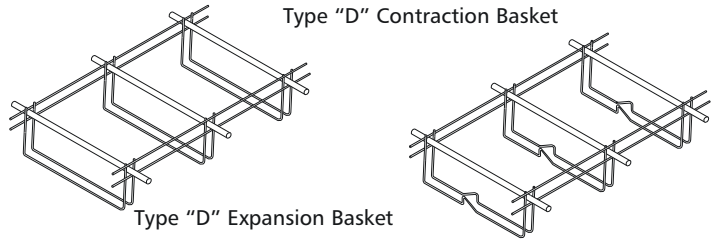

K-4 Type "D" Contraction Style

Cat I.D.	Part #	Description	Weight/Piece
K-4	81102	Legs @ 12" Ctrs	.081
K-4	81104	Legs @ 15" Ctrs	.075
K-4	81106	Legs @ 18" Ctrs	.071
K-4	81108	Legs @ 24" Ctrs	.066
K-4	80928	Legs @ 30" Ctrs	.063

K-5 Type "D" Expansion Style

Cat I.D.	Part #	Description	Weight/Piece
K-4	81112	Legs @ 12" Ctrs	.085
K-4	81114	Legs @ 15" Ctrs	.079
K-4	81116	Legs @ 18" Ctrs	.075
K-4	81118	Legs @ 24" Ctrs	.070
K-4	80929	Legs @ 30" Ctrs	.067

Tie Bar Assembly

Tie bar assembly is a basket supporting and positioning rebar dowels of various sizes as specified by the owner of the paving. It is commonly used for longitudinal joints in both DOT and commercial applications. Available in plain or epoxy coated. Call for special pricing.

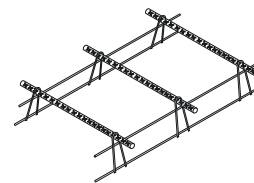

Dowel Bars

Dowel bars available in many different diameters and lengths. Specify plain, painted or epoxy. Other options include: patched ends, tectyl bond-breaker, fully or 3/5 painted, square, or round.

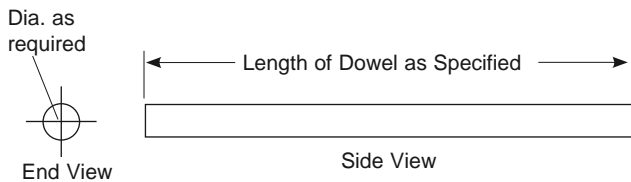

Tie Bars

Tie bars available in many different diameters and lengths. Straight or bent.

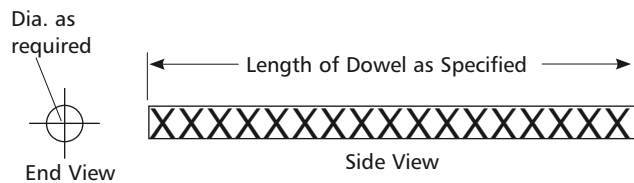

Cat. I.D.	Part #	Description (Plain) (Dia. & Length)*	Pcs/Pkg	Weight/Piece
F-38	DO3239	1/2" x 18"	1500	1.00
F-38	DO3074	5/8" x 18"	1000	1.57
F-38	DO2143	3/4" x 18"	800	2.25
F-38	DO3228	1" x 18"	400	4.01
F-38	DO3253	1 -1/4" x 18"	300	6.26
F-38	DO3052	1- 1/2" x 18"	200	9.01
F-38	D2124G60	2" x 24"	100	21.36

*Diameters and Lengths not shown on above table are also available from DS Paving Products

Cat. I.D.	Part #	Description* (Plain/Straight)	Weight/Piece
K-65	R03126	#4 x 24"	1.34
K-65	R03075	#4 x 36"	2.01
K-65	R03156	#5 x 24"	2.09
K-65	R03090	#5 x 36"	3.13
K-65	R02010	#6 x 24"	3.00
K-65	R00117	#6 x 30"	3.76
K-65	R03160	#6 x 36"	4.51
K-65	R03093	#8 x 24"	5.40
K-65	R00131	#8 x 30"	6.75
K-65	N/A	#8 x 36"	8.10

*Gauges and Lengths not shown on above table are also available from DS Paving Products.

Paving Systems

Basket Stake

Welded hook type stakes are available to anchor dowel baskets. The stakes are fabricated in 6" — 21" lengths and .306" and 1/2" diameters.

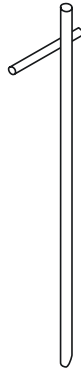

Cat. I.D.	Part #	Description	Pcs/Pkg	Weight/Piece
K-6	80081	0.306" x 6" long	N/A	0.16
K-6	80082	0.306" x 8" long	N/A	0.2
K-6	80083	0.306" x 10" long	N/A	0.25
K-6	80084	0.306" x 12" long	N/A	0.28
K-6	80091	0.306" x 14" long	N/A	0.33
K-6	80085	0.306" x 15" long	N/A	0.35
K-6	80086	0.306" x 18" long	N/A	0.41
K-6	80087	0.306" x 16" long	N/A	0.37
K-6	80080	0.306" x 17" long	N/A	0.39
K-6	80127	0.306" x 21" long	N/A	0.48
K-6	80088	0.306" x 12" long	100	0.28
K-6	80089	0.306" x 19" long	N/A	0.44
K-6	80090	.375" x 15" long	N/A	0.5
K-6	80101	.5" x 18" long (no hook)	N/A	1.0
K-6	80122	#4 x 19-1/2" long	N/A	1.145
K-6	80102	#4 x 18" long (no hook)	N/A	1.0

FS Stake

FS Stakes are available to hold dowel bars or tie bars in 6" — 11" thick slabs. They are fabricated in 5 gauge wire for 1/2" — 1-1/2" bar diameters.

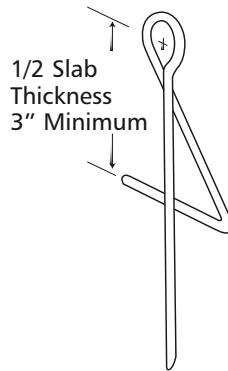

Cat. I.D.	Part #	Description	Pcs/Pkg	Weight/Piece
K-18	80357	1/2" x 3"	500	0.17
K-18	80358	1/2" x 3-1/2"	500	0.18
K-18	80359	1/2" x 4"	500	0.19
K-18	80360	1/2" x 4-1/2"	500	0.21
K-18	80361	1/2" x 5"	500	0.22
K-18	80362	1/2" x 5-1/2"	500	0.23
K-18	80377	5/8" x 3"	500	0.17
K-18	80378	5/8" x 3-1/2"	500	0.18
K-18	80379	5/8" x 4"	500	0.19
K-18	80380	5/8" x 4-1/2"	500	0.21
K-18	80381	5/8" x 5"	500	0.22
K-18	80382	5/8" x 5-1/2"	500	0.23
K-18	80389	5/8" x 6"	250	0.24
K-18	80383	3/4" x 3"	500	0.17
K-18	80384	3/4" x 3-1/2"	500	0.18
K-18	80385	3/4" x 4"	500	0.19
K-18	80386	3/4" x 4-1/2"	500	0.21
K-18	80387	3/4" x 5"	500	0.22
K-18	80388	3/4" x 5-1/2"	500	0.23
K-18	80363	1" x 3"—5"	250	0.23
K-18	80364	1-1/4" x 3"—5"	250	0.23
K-18	80365	1-1/2" x 3"—5"	250	0.23

MS Stake

MS Stakes are available to hold dowel bars or tie bars in 6" — 11" thick slabs. They are fabricated in 16 and 18 gauge metal for 1/2", 5/8", and 3/4" bar diameters.

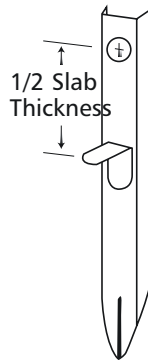

Cat. I.D.	Part #	Description	Pcs/Pkg	Weight/Piece
16 GAUGE				
K-15	80320	3" x 1/2"	200	0.32
K-15	80321	3-1/2" x 1/2"	200	0.33
K-15	80322	4" x 1/2"	200	0.35
K-15	80323	4-1/2" x 1/2"	200	0.36
K-15	80324	5" x 1/2"	200	0.38
K-15	80325	5-1/2" x 1/2"	200	0.41
K-15	80314	3" x 5/8"	200	0.32
K-15	80315	3-1/2" x 5/8"	200	0.33
K-15	80316	4" x 5/8"	200	0.35
K-15	80317	4-1/2" x 5/8"	200	0.36
K-15	80318	5" x 5/8"	200	0.38
K-15	80319	5-1/2" x 5/8"	200	0.41
K-15	80342	3" x 3/4"	200	0.32
K-15	80343	3-1/2" x 3/4"	200	0.33
K-15	80344	4" x 3/4"	200	0.35
K-15	80345	4-1/2" x 3/4"	200	0.36
K-15	80346	5" x 3/4"	200	0.38
K-15	80347	5-1/2" x 3/4"	200	0.41
K-15	80326	5/8" x 12"	200	0.32
18 GAUGE				
K-15	80330	3"	200	0.26
K-15	80331	3-1/2"	200	0.27
K-15	80332	4"	200	0.28
K-15	80333	4-1/2"	200	0.29
K-15	80334	5"	200	0.3
K-15	80335	5-1/2"	200	0.32
K-15	80336	3/4" x 11"	200	0.32

* All weights per 100 pieces unless otherwise noted.

Paving Systems

Fabric Stake

Fabric Stakes are available to anchor geotextile fabrics. They are fabricated in 18" lengths.

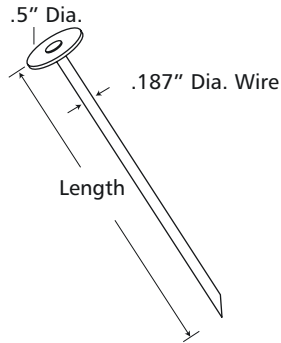

Cat. I.D.	Part #	Length	Pcs/Pkg	Weight/Piece
K-23	80825	18"	100	0.2

PS Stake

PS Stakes are available to hold dowel bars or tie bars in 6"—18" thick slabs. They are fabricated in #1/0 gauge wire for 1/2", 5/8", 1", 1-1/4", and 1-1/2" bar diameters.

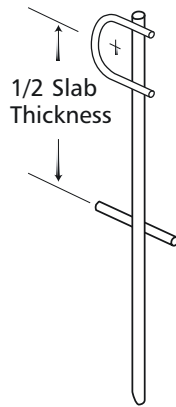

Cat. I.D.	Part #	Description	Weight/Piece
K-17	80348	Up to 3/4" x 3" high	0.26
K-17	80349	Up to 3/4" x 3-1/2" high	0.27
K-17	80350	Up to 3/4" x 4" high	0.28
K-17	80351	Up to 3/4" x 4-1/2" high	0.29
K-17	80352	Up to 3/4" x 5" high	0.3
K-17	80353	Up to 3/4" x 5-1/2" high	0.31
K-17	80354	Up to 3/4" x 6" high	0.32
K-17	80355	3/4" x 9" high	0.38
K-17	80366	1/2" - 3/4" bar, 13-1/2" O.L. N.G.S	0.34
K-17	80955	Up to 3/4" x 6-1/2" high	0.32
K-17	80956	Up to 3/4" x 7" high	0.34
K-17	80957	Up to 3/4" x 7-1/2" high	0.34
K-17	880351	Up to 1" x 4-1/2" high	0.29
K-17	880352	Up to 1" x 5" high	0.30
K-17	880353	Up to 1" x 5-1/2" high	0.31
K-17	880354	Up to 1" x 6" high	0.32
K-17	880366	Up to 1-1/2" bar, 13-1/2" O.L. N.G.S	0.34
K-17	880955	Up to 1" x 6-1/2" high	0.33
K-17	880956	Up to 1" x 7" high	0.34
K-17	880957	Up to 1" x 7-1/2" high	0.34
K-17	980351	1-1/4" - 1-1/2", 4-1/2" high	0.29
K-17	980352	1-1/4" - 1-1/2", 5" high	0.30
K-17	980353	1-1/4" - 1-1/2", 5-1/2" high	0.31
K-17	980354	1-1/4" - 1-1/2", 6" high	0.32

O.L. N.G.S. = Overall Length No Grade Stop at bottom

Channel Stake

Channel Stakes are available to support metal keyways in longitudinal and transverse joints of concrete slabs. They are fabricated in 14 and 16 gauge metal and 15"—24" lengths.



Cat. I.D.	Part #	Description	Pcs/Pkg	Weight/Piece
K-19	80370	14 ga. x 15" long	100	0.33
K-19	80371	14 ga. x 18" long	100	0.40
K-19	80374	16 ga. x 15" long	100	0.27
K-19	80375	16 ga. x 18" long	100	0.32
K-19	80376	16 ga. x 24" long	100	0.43

Paving Systems

Round Stakes

Solid steel round stakes are available for use as stringline stakes, form pins, and nail stakes. They are fabricated from A36 Steel in 3/4", 7/8", and 1" diameters, and 12", 18", 24", 30", 36", 42", and 48" lengths. They are also available with nail holes, 6 per 12" stakes, and 9 per other lengths.

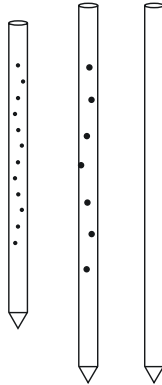

Standard Length	With Nail Holes Product Code No.	W/O Nail Holes Product Code No.	Weights Wt./100 units Pounds
3/4" Dia. G-27 Round Stakes			
12"	49735	49736	150.2
18"	49743	49744	25.3
24"	49751	49752	300.4
30"	49759	49760	375.5
36"	49767	49768	450.6
42"	49775	49776	525.7
48"	49783	49784	600.8
7/8" Dia. G-27 Round Stakes			
12"	49737	49738	204.4
18"	49745	49746	306.6
24"	49753	49754	408.8
30"	49761	49762	511.1
36"	49769	49770	613.3
42"	49777	49778	725.5
48"	49785	49786	817.7
1" Dia. G-27 Round Stakes			
12"	49739	49740	267.0
18"	49747	49748	400.5
24"	49755	49756	534.0
30"	49763	49764	667.5
36"	49771	49772	801.0
42"	49779	49780	934.5
48"	49787	49788	1068.0

Mat Stake

Mat Stakes are fabricated in 9", 12", 18", and 24" lengths.

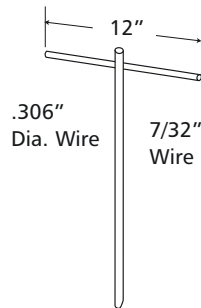

Cat. I.D.	Part #	Description	Pcs/Pkg	Weight/Piece
K-21	80390	12" x 9" penetration	100	0.19
K-21	80392	12" x 12" penetration	100	0.22
K-21	80394	12" x 18" penetration	100	0.27
K-21	80396	12" x 24" penetration	100	0.31

* All weights per 100 pieces unless otherwise noted.

Highway Fiber Expansion Joint™

Highway fiber expansion joint is an environmentally safe, compressible material used as a filler strip in expansion and contraction joints. It is suitable for use in a wide variety of concrete construction projects, including roadways, airport runways, loading facilities, parking lots, and curbs.

Meets ASTM-1751.

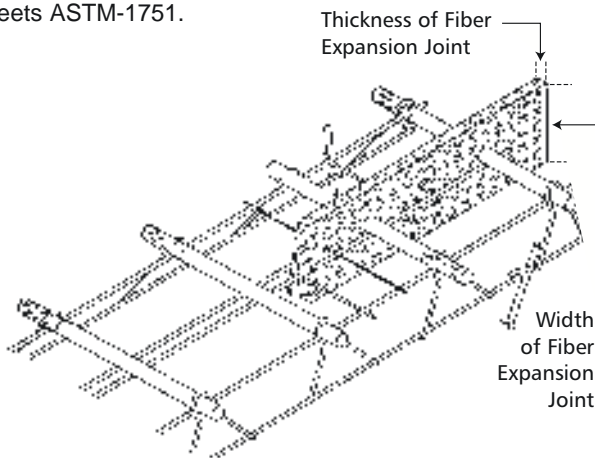

Cat. I.D.	Part #	Description
L-84	150004	1/4" x 4"
L-84	150008	1/4" X 8"
L-84	150027	3/8" X 4"
L-84	150031	3/8" X 6"
L-84	150053	1/2" X 6"
L-84	150057	1/2" X 8"
L-84	150061	1/2" X 10"
L-84	150075	3/4" X 6"
L-84	150079	3/4" X 8"
L-84	150083	3/4" X 10"
L-84	150103	1" X 9"
L-84	150109	1" X 12"

Add 15% for punched fiber.

Available Thicknesses of Fiber Expansion Joints: 1/4", 3/8", 1/2", 3/4", and 1".

Available Widths of Fiber Expansion Joints: 2" to 48"

Highway String Line Guide Systems

The Highway String Line Guide System is intended to be an aid or guide to users of automated paving equipment.

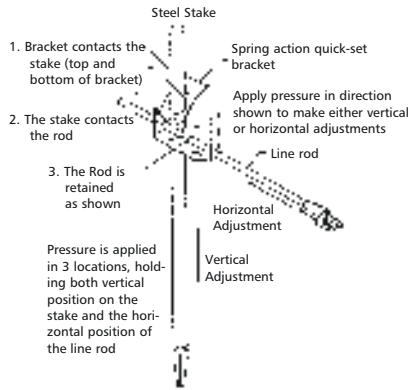

Cat. I.D.	Part #	Description
L0	121122	SAB Extruded Bracket, 3/4" Stakes, Hex Bolts
L0	121123	SAB Extruded Bracket, 3/4" Stakes, L-Bolts
L0	121124	One Piece Bracket, Zinc Plated, 3/4" Stake, 3/8" Line Rod
L0	121125	18" Slotted Rod, Zinc Plated, Hold 1/8" Diameter Stringline
L0	121126	18" Threaded Rod, Zinc Plated, Hold 3/8" Threaded Rod for Tips or Radius Clips
L0	121127	Replaceable Plastic Tip for 1/8" line, 3/8" Threaded Rod
L0	121128	Yellow Polyester Stringline w/Core, 1000 Foot Roll
L0	121129	White Polyester Stringline, 1000 Foot Roll
L0	121130	Winch
L0	121131	Stringline Reel

DS Paving Products Backer Rod™

DS Paving Products Backer Rod forms a sealant reservoir for joints or cracks in concrete or asphaltic pavement. It controls the depth of sealant, preventing sealant adhesion to the bottom sides of the joint. This product is used with either hot or cold applied sealants.

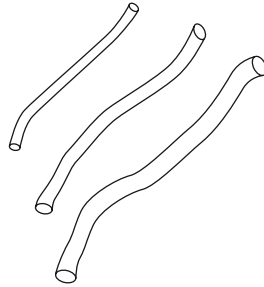

Closed Cell			
Cat. I.D.	Part #	Description	Ft/Ctn
L83	05020	1/4" Backer Rod	6400
L83	05021	3/8" Backer Rod	3600
L83	05022	1/2" Backer Rod	2500
L83	05023	5/8" Backer Rod	1550
L83	05024	3/4" Backer Rod	1100
L83	05025	1" Backer Rod	550
L83	05026	1-1/4" Backer Rod	400
L83	05027	1-1/2" Backer Rod	552
L83	05028	2" Backer Rod	360
L83	05029	3" Backer Rod	144
L83	05031	4" Backer Rod	90

**Open Cell also available, please call for price and availability

EPOXY COATING SERVICES Customer Supplied Material

In addition to coating our own product lines, Dayton Superior Paving Products offers custom coating services at our CRSI

certified facilities. The fusion-bonded epoxy coating application can be used for #4 and larger diameter bar with lengths between 30' and 60' at most facilities, as well as custom coating capabilities for other products. All items are first blast-cleaned with steel abrasives. The product is then heated. Powder particles are electrostatically charged, sprayed onto the product, and fusion-bonded. The CRSI certification for epoxy coating plants ensures you that we have the capabilities and quality control procedures in place to provide an excellent coating for your products.



Paving Systems

Basket Clips

Basket clips are available in wrap-around and nail-down styles to fasten baskets with nails in lieu of basket stakes.



Cat. I.D.	Part #	Description	Pce/Pkg	Weight/Piece
K-12	80302	Wrap-Around	n/a	0.082
K-12	80304	Nail-Down	n/a	0.057
K-12	80307	Wrap-Around for 3/0 Wire	n/a	0.082
K-12	80308	Nail-Down for 3/0 Wire Galvanized	n/a	0.057
K-12	125352	Wrap-Around Galvanized	n/a	0.082

Dowel Bar Clips

Dowel bar clips are available for tying or clipping dowels to K-4 and K-5 baskets. They are fabricated for 3/4" — 1-5/8" diameter dowels.

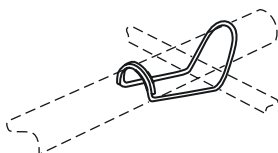

Cat. I.D.	Part #	Description	Pce/Pkg	Weight/Piece
K-14	80311	No. 1, 3/4" to 1"	2000	0.024
K-14	80312	No. 2, 1" to 1-3/8"	1000	0.039
K-14	80313	No. 3, 1/4" to 1-5/8"	1000	0.065

Dowel Tubes - Plastic

Plastic dowel tubes are used for the end-of-day pour applications, eliminating the need for drilling into the slab.

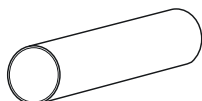

Cat. I.D.	Part #	Description	Pce/Pkg	Weight/Piece
K-11	122573	Plastic 1-1/4" x 18"	N/A	0.519
K-11	130000	Plastic 1-1/2" x 18"	N/A	0.574
K-11	130001	Plastic 1-3/8" x 20"	N/A	0.510

Dowel Caps

Metal and plastic dowel caps are available to allow movement of dowels in expansion joints. Crimp type metal dowel caps are fabricated in 5/8" — 1-1/4" diameters and 5" length. Welded type metal dowel caps are fabricated in 3/8" — 2" diameters and 5" and 6" lengths. Flanges on the welded type caps must be notched back when installing caps on dowels in baskets. Plastic dowel caps are fabricated in 1/2"—1-7/8" diameters and 4" length.

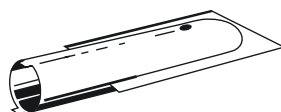

Crimp Type
I.D. = Nominal
Dia. + 1/16"

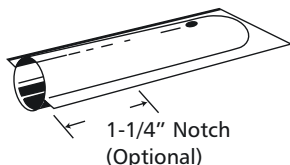

1-1/4" Notch
(Optional)

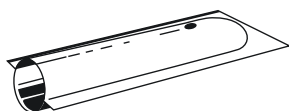

Welded Type
I.D. = Nominal Dia. + 1/8"



Plastic Caps
I.D. = Nominal Dia. + 1/32"

Cat. I.D.	Part #	Description	Pce/Pkg	Weight/Piece
Crimp Style				
K-11	60006	5/8" x 5"	500	0.089
K-11	60002	3/4" x 5"	500	0.1
K-11	60003	1" x 5"	500	0.135
K-11	60004	1-1/8" x 5"	500	0.14
K-11	60005	1-1/4" x 5"	250	0.147
Welded Type				
K-11	60001	1/2" x 5"	500	0.074
K-11	60010	7/8" x 5"	500	0.108
K-11	60020	1-1/8" x 6"	250	0.142
K-11	60026	1-3/8" x 6"	250	0.19
K-11	60027	1-1/2" x 6"	150	0.198
K-11	60028	1-3/4" x 6"	N/A	0.22
K-11	60029	2" x 6"	N/A	0.25
K-11	60019	1-1/8" x 5"	500	0.140
K-11	600270	1-1/2" x 8"	100	0.264
K-11	600271	1-1/2" x 6"	250	0.198
Plastic				
K-11	60007	1/2" x 4"	500	0.02
K-11	60032	5/8" x 4"	500	0.031
K-11	60009	3/4" x 4"	500	0.032
K-11	60033	3/4" x 6"	500	0.038
K-11	60034	7/8" x 4"	500	0.045
K-11	60017	1" x 4"	500	0.058
K-11	60018	1-1/8" x 4"	500	0.059
K-11	60025	1-1/4" x 4"	250	0.063
K-11	60035	1-3/8" x 4"	250	0.063
K-11	60036	1-1/2" x 4"	250	0.065
K-11	124196	1-7/8" x 4"	250	0.067

Paving Systems

Grout Retention Ring

Grout retention rings are available for 5/8", 3/4", 1", 1-1/4", and 1-1/2" diameter dowels. They retain anchoring material and improve dowel support.

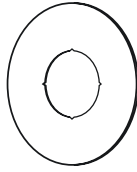

Cat. I.D.	Part #	Description	Pcs/Pkg	Weight/Piece
K-13	124689	5/8" Diameter	N/A	0.014
K-13	60071	3/4" Diameter	N/A	0.014
K-13	60072	1" Diameter	N/A	0.016
K-13	60074	1-1/4" Diameter	N/A	0.018
K-13	60076	1-1/2" Diameter	N/A	0.024

Snap-On Dowel Chair and Caps

Plastic dowel chairs are available for support of 1/2" through 1-1/2" diameter dowels used in retrofit applications. Contact DS Paving Products for pricing.

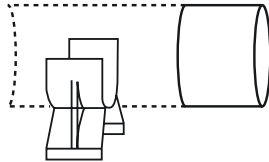

Cat. I.D.	Part #	Description	Weight/Piece
K-54	80788	1/2" for 1-1/2" Dowels	0.047
K-54	80789	1/2" for 1-1/2" Dowels(H)	0.018
K-54	80790	1/2" for 1-1/4" Dowels	0.017
K-54	121254	1-1/4" — Dwl Cap	0.022
K-54	121255	1-1/2" — Dwl Cap	0.028
K-54	220111	1-1/2" — Dwl Cap w/Chair	0.046
K-54	220110	1-1/4" — Dwl Cap w/Chair	0.039

Paving Coupler (1.25 PY)

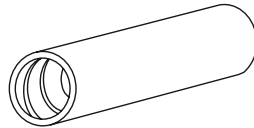

Cat. I.D.	Part #	Description	Size	Weight/Piece
K-25	80852	No. 4	3/4" x 1-3/4"	0.139
K-25	80854	No. 5	7/8" x 2"	0.197
K-25	80856	No. 6	1-1/16" x 2-1/8"	0.374
K-25	80858	No. 7	1-1/4" x 2-1/2"	0.597

Paving Coupler (1.50 PY)

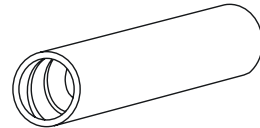

Cat. I.D.	Part #	Description	Size	Weight/Piece
K-26	80862	No. 4	3/4" x 1-3/4"	0.139
K-26	80864	No. 5	15/16" x 2"	0.247
K-26	80866	No. 6	1-1/8" x 2-1/8"	0.374
K-26	80868	No. 7	1-5/16" x 2-1/2"	0.597

Longitudinal Joint Ties

Bolts and couplers are available as longitudinal joint ties in 5/8" and 3/4" diameters. Bolts are fabricated in hook or wiggle configurations.



Coupler

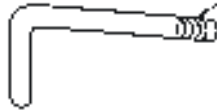

Rolled Thread

Wiggle Bolt

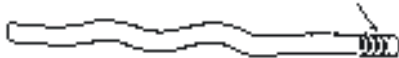

Rolled Thread

Cat. I.D.	Part #	Type and Size	Weight/Piece	Load Cap.
K-27-H	80869	K-27-H (AWC) 5/8" x 6"	0.77	15,000 lbs.
K-27-H	80883	K-27-H 5/8" x 6"	0.058	15,000 lbs.
K-27-H	80873	K-27-H 5/8" x 8"	0.07	15,000 lbs.
K-28-W	80871	K-28-W (AWC) 5/8" x 12"	1.0	15,000 lbs.
K-27-H	80877	K-27-H (AWC) 3/4" x 6"	1.01	24,000 lbs.
K-27-H	80885	K-27-H 3/4" x 6"	0.84	24,000 lbs.
K-27-H	80881	K-27-H 3/4" x 8"	1.04	24,000 lbs.
K-28-W	80879	K-28-W (AWC) 3/4" x 12"	1.53	24,000 lbs.
K-29	80887	K-29 5/8" Coupler	0.18	15,000 lbs.
K-29	80889	K-29 3/4" Coupler	0.17	24,000 lbs.

Dowel Aligner

Dowel aligners are available for alignment of 3/4" and 1" diameter dowels.

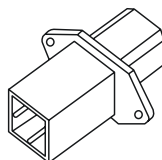

Cat. I.D.	Part #	Description	Pcs/Pkg	Weight/Piece
K-8	80305	3/4"	N/A	0.032
K-8	80306	1"	N/A	0.04

Paving Systems

Barrier Dowel Aligner

Barrier dowel aligners are available to locate four one-inch dowels in a traffic barrier. Each requires four dowel aligners.

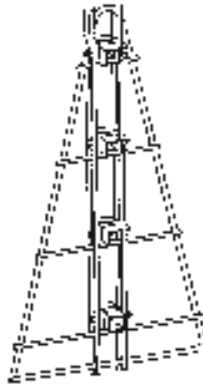

Mud Jack Tube

Mud jack tubes are available for bridge approach slabs from 12" — 16-1/2" thickness. The tube diameter is typically 2-1/2".

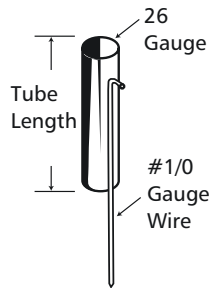

Cat. I.D.	Part #	Tube I.D.	Tube Length	Slab Thickness	Pcs/Pkg	Weight/Piece
K-24	80407	2-1/2"	11"	12"	100	1.2
K-24	80407	2-1/2"	12"	13"	100	1.25
K-24	80407	2-1/2"	13"	14"	100	1.3
K-24	80407	2-1/2"	14"	15"	100	1.35
K-24	80407	2-1/2"	15"	16"	100	1.4
K-24	80407	2-1/2"	15-1/2"	16-1/2"	100	1.45
K-24	80408	2-1/2"	w/o stake deduct		100	0.4

Vent Tube

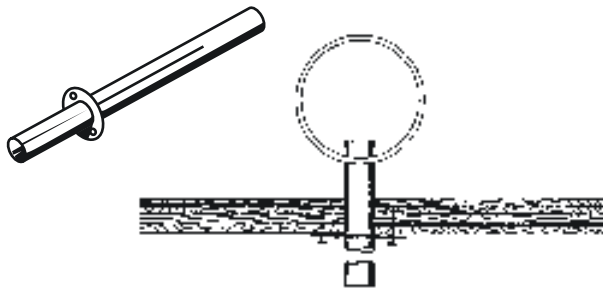

Cat. I.D.	Part #	Description	Pcs/Pkg	Weight/Piece
K-51	80890	3/4" O.D. x 12" overall	100	0.43

Cold Rolled Keyway

Cold rolled keyway is available for use with slip form pavers. They are fabricated in 24 or 26 gauge metal For 3-5/8" to 4-1/2" widths.

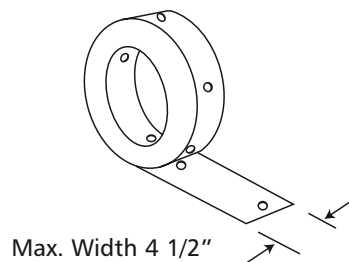

Cat. I.D.	Part #	GA.	Width	Spindle I.D.	Pcs/Pkg	Weight Lbs/ per 100 Ft.
K-36	80766	24	3-5/8"	16" or 20"	N/A	30.0
K-36	80767	24	4-1/4"	16" or 20"	N/A	35.0
K-36	80768	26	3-5/8"	16" or 20"	N/A	23.0
K-36	80769	26	4-1/4"	16" or 20"	N/A	26.0
K-36	80755	24	3-3/4"	16" or 20"	N/A	31.0
K-36	80756	26	3-1/4"	16" or 20"	N/A	20.0
K-36	80757	26	3-1/2"	16" or 20"	N/A	22.0
K-36	80758	26	3-3/4"	16" or 20"	N/A	23.0
K-36	80770	26	4"	16" or 20"	N/A	25.0

Paving Systems

Metal Keyway - Center Strip

Metal keyways are available to form keyways along longitudinal and transverse joints in concrete slabs. The false form, K-30, is fabricated in 16 and 18 gauge metal for 7-1/2" to 12" slabs.

The general center strip, K-33, is fabricated in 18 and 20 gauge metal for 4-1/2" to 10" slabs.

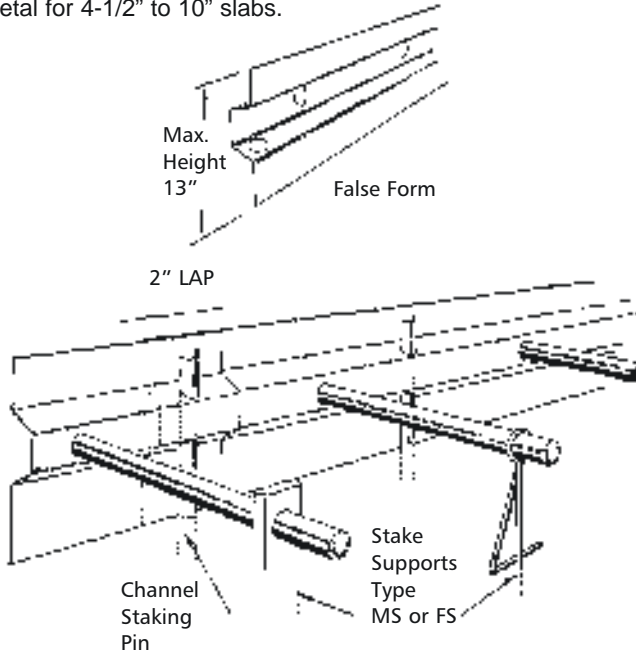

Cat. I.D.	Part #	False Form (18 GA.)	Pcs/Pkg	Weight/Piece
K-30	80523	7-1/2" for 8" slab	100	1.4
K-30	80526	8-1/2" for 9" slab	100	1.57
K-30	80529	9-1/2" for 10" slab	100	1.73
K-30	80532	10-1/2" for 11" slab	100	1.9
K-30	80535	11-1/2" for 12" slab	100	2.08
General Center Strip 18 GA.				
K-33	80580	4-1/2" for 5" slab	100	0.88
K-33	80582	5-1/2" for 6" slab	100	1.05
K-33	80584	6-1/2" for 7" slab	100	1.22
K-33	80586	7-1/2" for 8" slab	100	1.38
K-33	80588	8-1/2" for 9" slab	100	1.56
K-33	80590	9-1/2" for 10" slab	100	1.73
20 GA.				
K-33	80600	4-1/2" for 5" slab	100	0.66
K-33	80602	5-1/2" for 6" slab	100	0.79
K-33	80604	6-1/2" for 7" slab	100	0.92
K-33	80606	7-1/2" for 8" slab	100	1.04
K-33	80608	8-1/2" for 9" slab	100	1.17
K-33	80610	9-1/2" for 10" slab	100	1.3

Metal Keyway - Recess Form

Recess form keyways are available for longitudinal joints in 6" to 10" thick concrete slabs. They are fabricated in standard keyway deformation, K-34, or half-round deformation, K-35, in 24, 18, or 16 gauge metal.

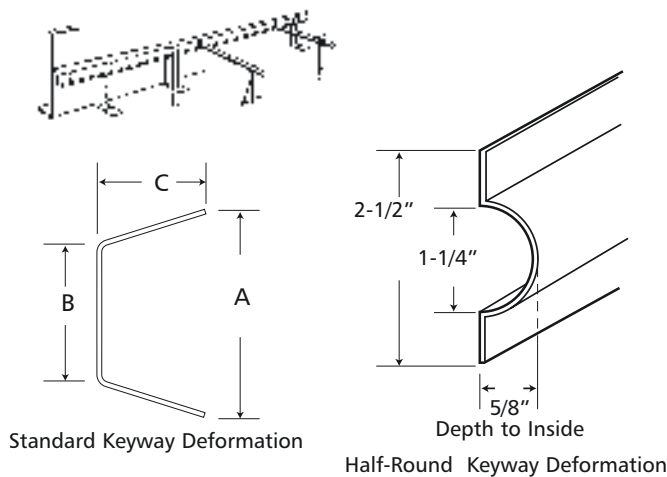

Cat. I.D.	Part #	Description	Pcs/Pkg	Weight/Piece
24 GA. (A-B-C) W/Legs				
K-34	80666	F#1 (1-1/4" x 3/4" x 1/2")	N/A	0.2
K-34	80668	F#2 (1-1/2" x 1" x 3/4")	N/A	0.25
K-34	80669	F#2A (1-1/2" x 1" x 1")	N/A	0.29
K-34	80673	F#3 (2-1/2" x 1-1/2" x 1")	N/A	0.4
K-34	80675	F#4 (2-1/2" x 2" x 1-1/8") 1/2" LIPS	N/A	0.54
K-34	80671	F#5 (3" x 2" x 1")	N/A	0.44
K-34	80676	F#6 (3-5/8" x 3" x 1-5/8")	N/A	0.68
K-34	80677	F#7 (3-1/2" x 2-1/2" x 1")	N/A	0.47
K-34	80678	F#8 (3" x 1-3/4" x 1")	N/A	0.41
K-34	80679	F#9 (2" x 1-1/2" x 1")	N/A	0.39
K-34	80680	F#10 (2-1/2" x 2" x 1")	N/A	0.43
K-34	80681	F#11 (4" x 3-1/2" x 1-1/2")	N/A	0.56
K-34	80682	F#12 (4" x 2" x 2")	N/A	0.52
K-34	80683	F#13 (2-3/4" x 1-3/4" x 1")	N/A	0.42
24 GA. (A-B-C) WO/Legs				
K-34	80736	F#1 (1-1/4" x 3/4" x 1/2")	N/A	0.12
K-34	80738	F#2 (1-1/2" x 1" x 3/4")	N/A	0.17
K-34	80739	F#2A (1-1/2" x 1" x 1")	N/A	0.21
K-34	80743	F#3 (2-1/2" x 1-1/2" x 1")	N/A	0.32
K-34	80745	F#4 (2-1/2" x 2" x 1-1/8") 1/2" LIPS	N/A	0.46
K-34	80741	F#5 (3" x 2" x 1")	N/A	0.36
K-34	80746	F#6 (3-5/8" x 3" x 1-5/8")	N/A	0.6
K-34	80747	F#7 (3-1/2" x 2-1/2" x 1")	N/A	0.39
K-34	80748	F#8 (3" x 1-3/4" x 1")	N/A	0.33
K-34	80749	F#9 (2" x 1-1/2" x 1")	N/A	0.31
K-34	80750	F#10 (2-1/2" x 2" x 1")	N/A	0.35
K-34	80751	F#11 (4" x 3-1/2" x 1-1/2")	N/A	0.48
K-34	80752	F#12 (4" x 2" x 2")	N/A	0.44
K-34	80753	F#13 (2-3/4" x 1-3/4" x 1")	N/A	0.34
Half-Round Keyway W/Legs				
K-35	80765	F#1 (1-1/4" x 5/8")	N/A	0.34
Half-Round Keyway WO/Legs				
K-35	N/A	F#1 (1-1/4" x 5/8")	N/A	0.26

Bar Supports

Transverse Bar Assembly (TBA)

Eliminates wire tying to longitudinal bar for CRCP replacement. Transverse reinforcement hooks directly to longitudinal bar. Snaps quickly to track. Saves labor, as a six person crew can typically lay one lane mile per 8 hour shift. Accurate position of clips creates uniform separation for continuous bar placement. Custom manufactured to specs in both uncoated or epoxy coated.

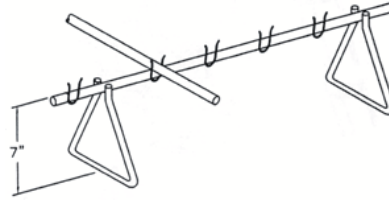

Continuous Mesh Support

Continuous mesh supports are manufactured in 5' 0" lengths and 3", 4", 5" 6", and 7" heights.

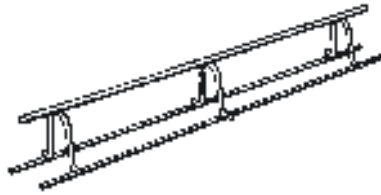

Cat. I.D.	Part #	Description	Pcs/Pkg	Weight/Piece
K-60	80473	3" x 5'	N/A	0.36
K-60	80474	4" x 5'	N/A	0.38
K-60	80475	5" x 5'	N/A	0.4
K-60	80476	6" x 5'	N/A	0.42
K-60	80477	7" x 5'	N/A	0.46

Continuous High Chair Upper (CHCU)

These continuous supports are available in 2" through 25" heights. They are fabricated in Bright Basic Wire (CHCU-3) or Epoxy-coated Wire. Per 100 Ft. or Per 100 Pcs.

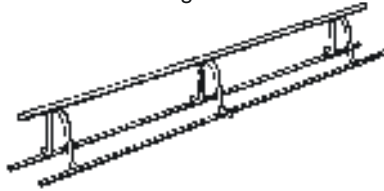

Continuous High Chair Upper	Pkg. Unit Standard Feet Standard (Feet)	Approx. Wt. Lbs./ 100 Ft. or 100 Pcs.
2" to 3" high incl.	100	62
Over 3" to 4" high incl.		66
Over 4" to 5" high incl.	100	69
Over 5" to 6" high incl.	100	83
Over 6" to 7" high incl.	100	88
Over 7" to 8" high incl.	100	93
Over 8" to 9" high incl.	100	98
Over 9" to 10" high incl.	100	122
For each inch or fraction over 10" (Add 7 lbs. per 100 ft.)		

Continuous High Chair (CHC)

Continuous high chairs provide reinforcing steel support from 2" to 20" heights. They are available in Bright Basic Wire (CHC-3), Galvanized Wire (CHC-GW), Stainless Steel, Plastic Protected Legs (CHC-1), and Epoxy-coated Wire, 2" through 20" high. Per 100 Ft. or Per 100 Pcs.

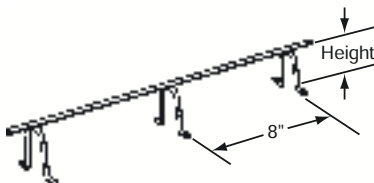

Continuous High Chair	Pkg. Unit Standard Feet Standard (Feet)	Approx. Wt. Lbs./ 100 Ft. or 100 Pcs.
2" to 3" high incl.	100	32
Over 3" to 4" high incl.	100	36
Over 4" to 5" high incl.	100	39
Over 5" to 6" high incl.	100	53
Over 6" to 7" high incl.	100	58
Over 7" to 8" high incl.	100	63
Over 8" to 9" high incl.	100	68
Over 9" to 10" high incl.	100	92
Over 10" to 11" high incl.	50	99
Over 11" to 12" high incl.	50	106
Over 12" to 13" high incl.	50	113
Over 13" to 14" high incl.	50	119
Over 14" to 15" high incl.	50	126

Bar Supports

Continuous Support

Continuous supports are available for wire mesh support in 2" through 16" heights.

9" to 16" Heights
Have Three Linear
Wires

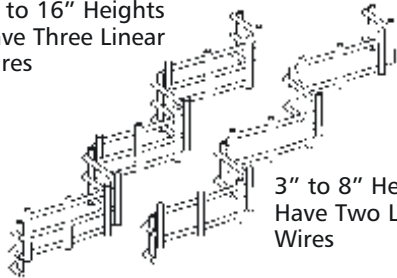

3" to 8" Heights
Have Two Linear
Wires

Cat. I.D.	Part #	Description	Pcs/Pkg	Weight/ Piece
CS	84220	2" Height Con. Mesh Support	9600	0.177
CS	84222	2-1/2" Height Con. Mesh Support	9600	0.183
CS	84224	3" Height Con. Mesh Support	9600	0.186
CS	84226	3-1/2" Height Con. Mesh Support	8000	0.194
CS	84228	4" Height Con. Mesh Support	8000	0.197
CS	84230	4-1/2" Height Con. Mesh Support	7200	0.201
CS	84232	5" Height Con. Mesh Support	6400	0.213
CS	84234	5-1/2" Height Con. Mesh Support	5600	0.221
CS	84235	5-3/4" Height Con. Mesh Support	5600	0.225
CS	84236	6" Height Con. Mesh Support	4800	0.317
CS	84238	6-1/2" Height Con. Mesh Support	4800	0.326
CS	84240	7" Height Con. Mesh Support	4000	0.335
CS	84242	7-1/2" Height Con. Mesh Support	3200	0.443
CS	84244	8" Height Con. Mesh Support	3200	0.452
CS	84246	8-1/2" Height Con. Mesh Support	3200	0.462
CS	84248	9" Height Con. Mesh Support	3200	0.471
CS	84250	9-1/2" Height Con. Mesh Support	2560	0.482
CS	84252	10" Height Con. Mesh Support	2560	0.491
CS	84253	10-1/4" Height Con. Mesh Support	2560	0.495
CS	84254	10-1/2" Height Con. Mesh Support	2560	0.498
CS	84255	10-3/4" Height Con. Mesh Support	2560	0.504
CS	84256	11" Height Con. Mesh Support	2560	0.508
CS	84258	11-1/2" Height Con. Mesh Support	1920	0.516
CS	84259	11-3/4" Height Con. Mesh Support	1920	0.521
CS	84260	12" Height Con. Mesh Support	1920	0.526
CS	84262	12-1/2" Height Con. Mesh Support	1920	0.528
CS	84264	13" Height Con. Mesh Support	1920	0.537
CS	84266	13-1/2" Height Con. Mesh Support	1920	0.542
CS	84268	14" Height Con. Mesh Support	1920	0.555
CS	84272	15" Height Con. Mesh Support	1920	0.573
CS	84274	15-1/2" Height Con. Mesh Support	1920	0.581
CS	84276	16" Height Con. Mesh Support	920	0.590

Snap-On Paving Chair (#3, #4)

Plastic, snap-on paving chairs are available for #3 and #4 Rebar. They are manufactured in 1" through 6" heights and are also available with a square base.

Cat. I.D.	Size	Part# w/Base	Pcs/ Carton	Wt./ Carton	Part# wo/Base	Pcs/ Carton	Wt./ Carton
R-20	1"	62302	500	30	62352	1000	26
R-20	1-1/2"	62304	500	30	62354	1000	28
R-20	1-3/4"	62306	500	28	62356	1000	30
R-20	2"	62308	500	29	62358	1000	28
R-20	2-3/16"	62310	500	29	62360	500	26
R-20	2-1/2"	62312	500	28	62362	500	28
R-20	3"	62314	250	29	62364	500	30
R-20	3-3/16"	62316	250	30	62366	500	28
R-20	3-1/2"	62318	250	28	62368	500	30
R-20	3-3/4"	62320	250	28	62370	500	28
R-20	4"	62322	250	28	62372	500	30
R-20	4-3/16"	62324	250	29	62374	500	32
R-20	4-1/2"	62326	250	30	62376	500	33
R-20	4-3/4"	62328	250	31	62378	250	30
R-20	5"	62330	250	28	62380	250	31
R-20	5-1/4"	62332	250	30	62382	250	30
R-20	5-1/2"	62334	150	28	62384	150	32
R-20	6"	62336	150	28	62386	150	26

Bar Supports

Snap-On Paving Chair (#4, #5, #6)

Plastic, snap-on paving chairs are available for #4, #5, and #6 Rebar. They are manufactured in 1" through 7" heights and are also available with a square base.

Cat. I.D.	Size	Part# w/Base	Pcs/ Carton	Wt./ Carton	Part# wo/Base	Pcs/ Carton	Wt./ Carton
R-21	1"	62404	500	31	62454	1000	28
R-21	1-1/2"	62406	500	28	62456	1000	29
R-21	1-3/4"	62408	500	29	62458	1000	30
R-21	2"	62410	500	30	62460	1000	30
R-21	2-3/16"	62412	250	28	62462	600	32
R-21	2-1/2"	62414	250	28	62464	600	28
R-21	3"	62416	250	28	62466	600	28
R-21	3-3/16"	62418	250	30	62468	600	28
R-21	3-1/2"	62420	250	29	62470	600	30
R-21	3-3/4"	62422	250	30	62472	600	28
R-21	4"	62424	250	28	62474	500	30
R-21	4-3/16"	62426	250	30	62476	500	28
R-21	4-1/2"	62428	250	28	62478	500	30
R-21	4-3/4"	62430	250	30	62480	500	28
R-21	5"	62432	250	28	62482	400	30
R-21	5-1/4"	62434	150	29	62484	400	28
R-21	5-1/2"	62436	150	30	62486	400	30
R-21	6"	62438	150	26	62488	150	26
R-21	6-3/16"	62440	150	28	62490	150	28
R-21	7"	62442	150	26	62492	150	30

Snap-On Power Chair

Snap-on power chairs are available to support #3 Rebar at heights from 1" through 6". They are manufactured from glass-reinforced resin for high heat resistance and high strength and have an optional square base.

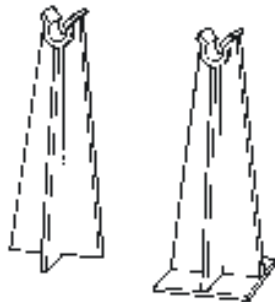

Cat. I.D.	Size	Part# w/Base	Pcs/Carton	Wt./ Carton	Part# wo/Base	Pcs/Carton	Wt./ Carton
R-25	1"	62602	500	32	62652	1000	26
R-25	1-1/2"	62604	500	30	62654	1000	28
R-25	1-3/4"	62606	500	32	62656	1000	29
R-25	2"	62608	500	28	62658	1000	30
R-25	2-3/16"	62610	250	28	62660	600	32
R-25	2-1/2"	62612	250	30	62662	600	28
R-25	3"	62614	250	28	62664	600	28
R-25	3-3/16"	62616	250	28	62666	600	28
R-25	3-1/2"	62618	250	30	62668	600	30
R-25	3-3/4"	62620	250	28	62670	600	28
R-25	4"	62622	250	28	62672	500	28
R-25	4-3/16"	62624	250	28	62674	500	30
R-25	4-1/2"	62626	250	30	62676	500	32
R-25	4-3/4"	62628	250	32	62678	500	28
R-25	5"	62630	250	28	62680	400	30
R-25	5-1/4"	62632	150	30	62682	400	28
R-25	5-1/2"	62634	150	26	62684	400	30
R-25	6"	62636	150	28	62686	50	26

Mesh Chair

Plastic mesh chairs are available for mesh support at heights from 1" through 6". A square base is also available.

Cat. I.D.	Size	Part# w/Base	Pcs/Carton	Wt./ Carton	Part# wo/Base	Pcs/Carton	Wt./ Carton
R-22	1"	62502	500	32	62552	1000	26
R-22	1-1/2"	62504	500	30	62554	1000	28
R-22	2"	62508	500	28	62558	1000	30
R-22	2-3/16"	62510	500	28	62560	1000	32
R-22	2-1/2"	62512	500	30	62562	500	28
R-22	3"	62514	250	28	62564	500	28
R-22	3-3/16"	62516	250	28	62566	500	28
R-22	3-1/2"	62518	250	30	62568	500	30
R-22	3-3/4"	62520	250	28	62570	500	28
R-22	4"	62522	250	28	62572	500	28
R-22	4-1/2"	62526	250	30	62576	500	32
R-22	4-3/4"	62528	250	32	62578	250	28
R-22	5"	62530	250	28	62580	250	30
R-22	5-1/4"	62532	250	30	62582	250	28
R-22	5-1/2"	62534	150	26	62584	400	30
R-25	6"	62536	150	28	62586	400	26

Forms

Heavy Duty Forms

For almost a century, the Dayton-Superior Companies have been in the paving forms manufacturing business, providing quality core products to a network of contractors and distributors. When an addition to your edge form inventory is required, please contact us for a custom quotation. We guarantee to turn around all proposals within 24 hours. DS Paving Products manufactures forms meeting any paving requirement.

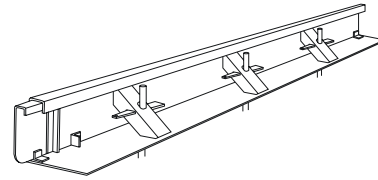

Curb and Gutter Forms

Versatile product line that adapts to many different concrete forming conditions. It is ideally suited for applications that include sidewalks, curbs and gutters, and pavements. This forming system features durable steel components, with added reinforcement, for maximum service life. These components are precision-welded to provide a system that lasts far longer than conventional lumber edge forms.

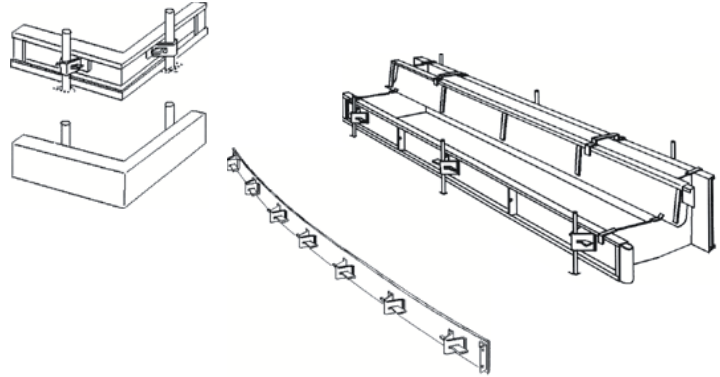

2 in 1 Forms

This permits the placement of two slab thicknesses with one reversible form.

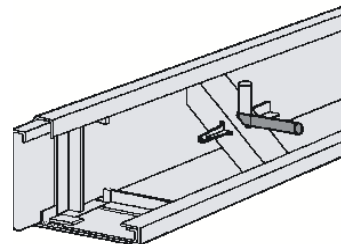

Paving Form Options

- Double Wedge Stake Pockets
- Reinforcing Gussets
- Dowel Bar Support Assemblies
- Keyway Attachments
- Turned Up Bottom Flange

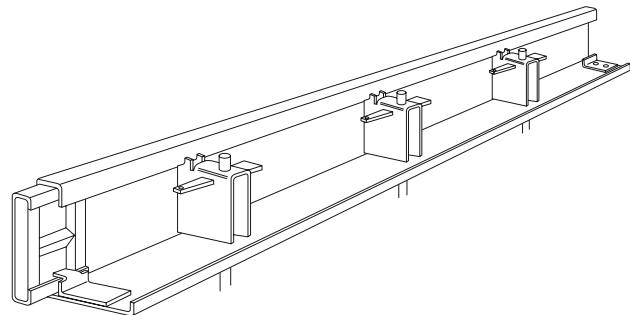

Forms

Highway Dowel Hole and Keyway Section

- Standard 10' length.
- Product #32499 — Dowel hole (punched on request, specify location).
- Product #32526 — 10' keyway section (1-5/8" top x 1-3/4" depth x 2-3/4" base)
- Includes mounting (welded or bolted)
- Specify mounting location

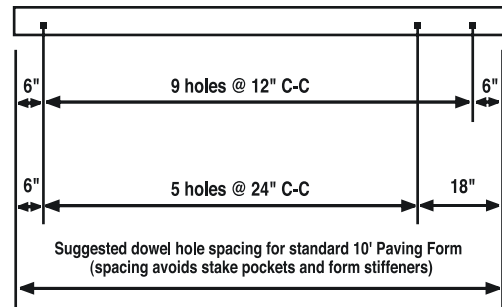

Heavy Duty Concrete Paving Screed

Engineered for low slump, high production pours. Heavy-duty design assures accurate finishes and long-term reliability. Unlike other models, our heavy duty screed normally requires just one pass.

OPTIONS

- Hydraulic Winches
- Off-Set Plates
- Transport Unit

DIMENSIONS

Width: Variable in 2-1/2', 5' and 10' sections

POWER

Honda 8 h.p. or 11 h.p. engine options

CLUTCH

Centrifugal clutch with dual belt drive

WINCH

Heavy-duty winches with 75' of 1/8" high strength

BEARINGS

Pillow block, self-aligning, grease type

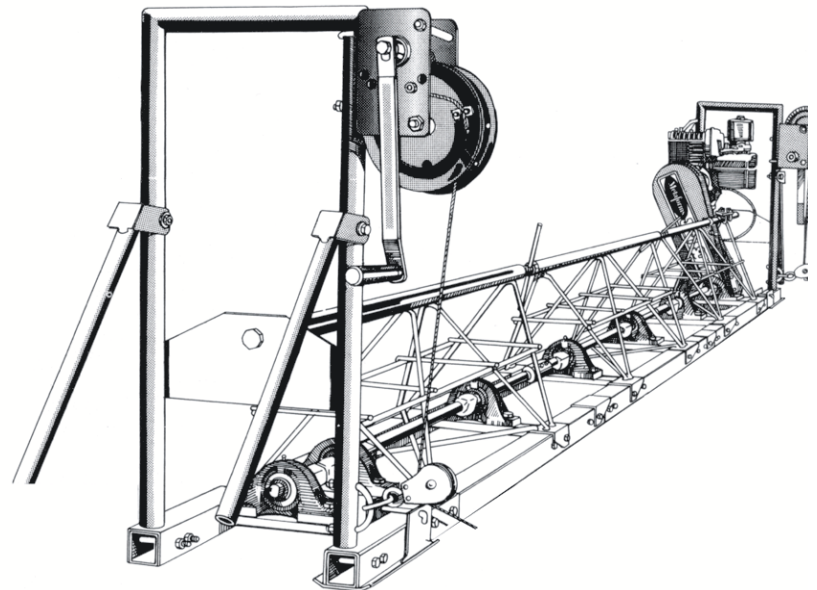
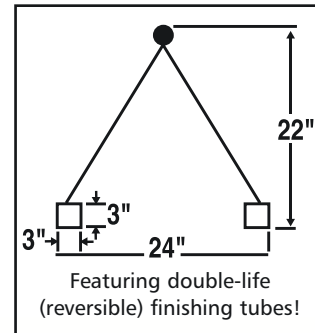

Chemicals

Liquid Surface Treatments

TYPE II, Class A CURE™

(formerly "Highway White Cure Water Base-W")

Water-based + State D.O.T. + ASTM C 309

A true water-based, with pigmented curing compound containing white pigments and other solids in suspension. Type II, Class A CURE is a water-based formulation and as a result it contains no organic solvents, is environmentally safe, and is V.O.C. compliant.

Conforms to ASTM-C-309 Type II, Class A; AASHTO M 148 Type II, Class A; CRD-C 300 available.

TYPE II, Class B CURE™

(formerly "Highway White Cure Water Base-R")

Resin-based + State D.O.T. + ASTM C 309

A resin based white pigmented curing compound meeting ASTM-C-309. Type II, Class B CURE is ready-mixed for immediate use without alteration. It provides a uniform white appearance when applied uniformly to new concrete surfaces at the recommended coverage rate. The product is V.O.C. compliant.

Conforms to: ASTM-C-309 Type II, Class B; AASHTO M 148 Type 2, Class B; CRD-C 300 available.

TYPE I-D, Class B CURE™

(formerly "Highway All-Resin Cure")

Resin Cure + D.O.T. + ASTM C 309

Type I-D, Class B CURE is an all-resin base curing compound. Conforms to: ASTM-C-309 Type I-D, Class B; AASHTO M 148 Type I-D, Class B; Also available with red fugitive dye; (Type I-D, Class A); CRD-C 300 available.

TYPE I, Class A CURE™

A true water based, clear liquid curing compound meeting ASTM-C-309. Type I, Class A CURE is ready-mixed for immediate use without alteration. It provides a continuous film when applied uniformly to new concrete surfaces at the recommended coverage rate. The product is V.O.C. compliant.

Conforms to: ASTM C 309 Type I, Class A; AASHTO M 148 Type I, Class A; CRD-C-300 formulation also available.

TYPE I, Class B CURE™

A liquid, resin based, clear curing compound meeting ASTM-C-309. Type I, Class B CURE is ready-mixed for immediate use without alteration. It provides a continuous film when applied uniformly to new concrete surfaces at the recommended coverage rate. The product is V.O.C. compliant.

Conforms to: ASTM-C-309 Type I, Class A; AASHTO M 148 Type I, Class B; CRD-C-300 formulation also available.

City White CURE™

Water Based + ASTM C 309

A true water based, white pigment curing compound containing white pigments and other solids in suspension. City White CURE is a water based formulation and, as a result, it contains no organic solvents, is environmentally safe, and is V.O.C. compliant.

Conforms to: ASTM C 309 TYPE II, Class A

Cat. I.D.	Part #	Description
J-8	200463	City White Cure 55 Gal

Linseed Anti-Spall™

DS Paving Products-Linseed Anti-Spall® is a uniform blend of mineral spirits and boiled linseed oil. This anti-spalling sealer for protecting concrete has a light amber color.

Conforms to: AASHTO M 233, standard specification for "Boiled Linseed Oil Mixture for Treatment of Portland Cement Concrete."

Cat. I.D.	Part #	Description
J-33	69090	55 GL Drum Anti-Spall Boil
J-33	69091	5 GL Pail Anti-Spall Boil

EV-RET 302

Evaporation Retardant and Finishing Aid

EV-RET 302 is a ready to use water based evaporation retardant for concrete paving. EV-RET 302 reduces surface moisture evaporation in rapid-drying conditions (high temperature - low humidity - wind - direct sun). This allows time for proper finishing and helps in preventing plastic shrinkage of the concrete slab.

EV-RET 302 allows additional time, when applying surface hardeners, to properly finish and later cure the slab. V.O.C. compliant.

EV-RET 302-Ready to Use

Description
55 Gallon Drum
275 Gallon Tote

Chemicals

Epoxy Adhesives

Highway Epoxy™

Epoxy Gel Adhesive

Highway Epoxy is a 100% solid, high modulus, high strength, epoxy gel adhesive. It is a two component, moisture-insensitive structural epoxy adhesive that meets ASTM C 881. Highway Epoxy is available in cartridges for easy dispensing, as well as larger, gallon units.

Cat. I.D.	Part #	Description
J-51	69358	51 oz. Cartridge
J-51	150118	2-1 Gal. Pails
J-51	150120	10 Gal. Units

Epoxy Patch Kit

Kits are available for field patching of epoxy coated dowels. One two-part 5 lb. kit provides coverage for both ends of approximately 1200 1" diameter dowels.

Cat. I.D.	Part #	Description
J-62	95049	1200 Dowels (Both Ends)
J-62	69660	Highway Rebar Epoxy Spray (Green)

Highway Fast Set Epoxy™

Fast setting, epoxy gel adhesive, ICBO listed.

Highway Fast Set Epoxy™ is a fast-setting epoxy for anchoring bolts, dowels, and reinforcing steel into concrete. It is also ideal for vertical and horizontal structural bonding and patching. Meets ASTM-C881.

Cat. I.D.	Part #	Description
J-51	150116	22 oz. Cartridge
J-51	150117	2-1 Gal. Pails
J-51	150119	10 Gal Units

Available accessories:

Highway Epoxy Injection Ports - (Diameter=.25")

Highway Epoxy Cartridge Gun - (Heavy Duty-Manual)

Highway Epoxy Cartridge Gun - (Heavy Duty-Air Powered)

Highway Nozzle Mixers for Epoxy Cartridges No. 35 - (O.D.=.37", L=9.5") Recommended for use with Highway Fast Set Epoxy cartridge (includes nut; large nut product code no. 69801).

Highway Nozzle Mixers for Epoxy Cartridges No. 37 - (O.D.=.51", L=9.3") Recommended for use with Highway Fast Set Epoxy cartridge (includes nut; large nut product code no. 69801).

Highway Nozzle Mixers for Epoxy Cartridges No. 49 - (O.D.=.66", L=9.1") Recommended for use with Highway Fast Set Epoxy cartridge (includes nut).

Chemicals

Cementitious Products

Prime Highway Patch

Prime Patch is Dayton Superior Paving Products's most economical repair material for those jobs that do not need high early strengths. When traffic control procedures allow more time for the repair material to harden, Prime Patch is the material of choice. Prime Patch is a portland cement based material that reaches 3000 psi in 12 hours. It has excellent workability properties and no special handling requirements. Prime Patch can be purchased in super sacks or 50# bags.

	Formula	Container
280847	EAR Prime Highway Patch	50# bag
306216	EAR Prime Patch	50# bag

Skill Highway Patch

Skill Patch is a portland cement based repair material that allows opening to traffic in a matter of hours. Skill Patch was designed to be an economical solution to time sensitive rehabilitation needs in the transportation market. Impressive strength gains with 100% extension rates make Skill Patch an attractive material for Department of Transportation work. No special equipment is required for mixing or placing the material. Skill Patch is a fast setting material that is normally purchased as a blended (powder and sand) product in 50# bags.

	Formula	Container
306215	Special	50# bag

Master Highway Patch

Master Patch is a rapid setting material designed to minimize down time while providing long term durability. Master Patch is a portland cement based material that can be extended with coarse aggregate to maximize economies and meets the criteria for ultra rapid setting patching materials maintained by AASHTO's National Testing Product Evaluation Procedures (NTPEP). Repair areas can be opened to traffic within hours of placement. Master Patch has excellent workability characteristics and is available in powder form to allow contractor batching, or can be purchased as a blended material (powder and sand) in super sacks or 50# bags.

	Formula	Container
280934	EAR Master Highway Patch	50# bag
301922	EAR Master Traffic Patch	50# bag

Xtreme Highway Patch

Xtreme Patch is formulated for use in high performance pavements, specifically.

Industrial

Beyond its use on bridges and highways, Xtreme Patch has many applications in industrial and commercial facilities due to its flexibility, anti-spalling, high load-bearing and resistance to chemicals. Easy to install and rapid curing in normal temperatures make Xtreme Patch your special needs solution.

Airfield Pavements

Major airports use Xtreme Patch for critical concrete pavement

repair. Xtreme Patch's flexibility and ability to resist spalling and cracking make it an excellent choice for casting airfield pavement lighting in new or reinstallation applications. Xtreme Patch bonds well to both steel and concrete.

	Formula	Container
Xtreme Patch	Special	25 gal unit

PROPERTIES CHART

Properties	Prime	Skill	Master	Xtreme
Compressive Deflection	—	—	—	800-1400psi
Compressive Strength				
3 Hours	3000psi	4000psi	4000psi	—
1 Day	5000psi	6000psi	7000psi	—
Extension	60%	100%	100%	—
Yield/Unit	0.60 cu.ft.	0.75 cu.ft.	0.75 cu.ft.	3.3 cu.ft.
Bond Strength	2000psi	2500psi	3000psi	—

Dowel Bar Retrofit System

(Complete Brochure Available Upon Request)

What is a Dowel Bar Retrofit System?

Load transfer is the ability of a joint or crack in concrete pavement to transfer load from one slab to the next through shear action. Good load transfer improves concrete pavement performance by reducing tensile stresses in concrete, reducing corner deflection, and reducing differential deflection.

The Dowel Bar Retrofit System (DBRS) is a rehabilitation technique for increasing the load transfer capability of existing jointed portland cement concrete (PCC) pavement. This is accomplished by placing dowel bars (where not previously existing) across joints and/or cracks that exhibit poor load transfer.

Qualifications for the System

The DBRS is well suited for jointed concrete pavements that have poor load transfer at joints and/or cracks but also have significant remaining structural life.

Condition Indicators

The following field conditions have been identified as indicators that an individual joint or crack would benefit from DBRS:

- Deflection load transfer of 60% or less.
- Faulting greater than 2.5mm.
- Differential deflection of 250 um (10 mils) or more.

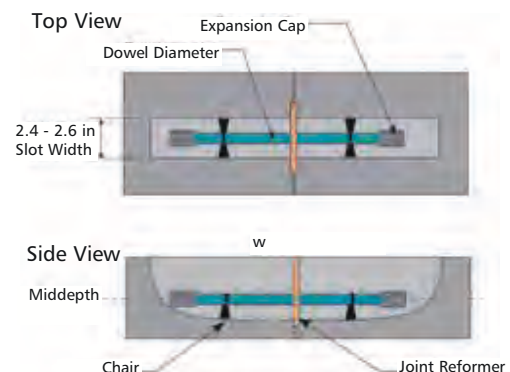

Chemicals

Cementitious Products - *continued*

Superior Retrofit Mortar Material

Research indicates that the success or failure of a retrofit load transfer system depends upon the following; (1) performance of the load transfer device, (2) preparation of the slot faces to ensure good bonding, and (3) long-term performance of the retrofit mortar. DS Paving Products has developed a superior retrofit mortar to use specifically for this application.

- Unique placement workability.
- Exhibits little or no shrinkage.
- Rapidly develops necessary physical properties for early re-opening to traffic.
- Accommodates the thermal stresses caused by daily curling of the slab.
- Superior bond to all properly prepared surfaces.

DBR Mortar Material Offerings

DBR mortar concentrate is available neat as a cementitious powder in 2500 lb. supersacks ready to be mixed on the job site with both sands and aggregate. This is the most economical approach for material delivery. In addition, a DBR sand and powder pre-blend material is now available in both bags and supersacks.

	Formula	Container
Dowel Bar Retrofit Mortar Blend	Special	50# bag
Dowel Bar Retrofit Mortar Neat	Neat	2500#SS

Performance

In the State of Washington, starting in 1991, over 200 center-line miles have successfully been retrofitted with load transfer dowel bar placement.

With an average installation cost of only \$30 per dowel, drivers are now experiencing a smoother ride while the state is saving millions of dollars by employing this innovative rehabilitation system.

States utilizing the dowel bar retro-fit system on a major scale are: Wyoming, the Dakotas, Wisconsin, Nebraska and Kansas. Those moving in this direction currently include New York, Iowa, and Oklahoma.

DBRS — The Best in the Business

Several types of devices have been used to restore load transfer across joints and cracks in existing pavements, but research proves that the DBRS utilization of smooth round dowel bars are superior because of their proven long-term performance and cost-effectiveness.

DS Paving Products Savings

Our survey indicates that in recent years projects not using the DS Paving Products retrofit system were costing up to \$100 per dowel. With our system, the cost per dowel in routine installations have averaged between \$25.00-\$35.00.



Preparing the slots.

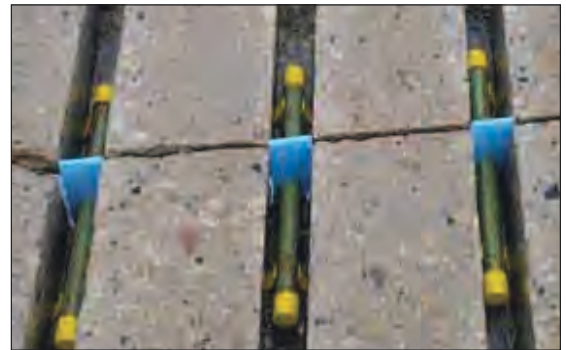

Placing the dowel bars, caps, chairs and joint filler.



Backfilling the slots with DB Retrofit Mortar.

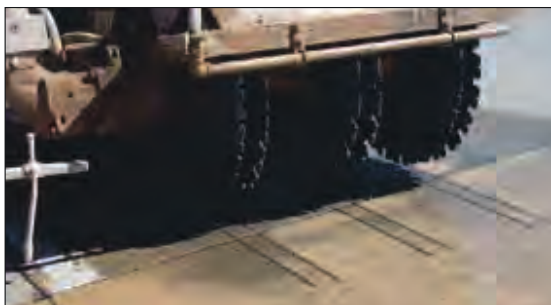

Cutting the slots (sawing).



Diamond grinding of pavement lane.



Chemicals

Joint Sealing Products

Highway Liquid Joint Sealants™

Highway Liquid Joint Sealant[®] is a hot-applied, one-part sealant for use in sealing expansion joints, contraction joints, and random cracks in concrete and asphaltic pavements.

Advantages: Provides high resiliency and weather resistance; withstands freeze/thaw cycles; seals cracks and joints from water penetration; meets ASTM-D3405.

3405-HP Joint Sealant

DESCRIPTION

This hot pour sealant is a quality, hot applied, one component rubber asphalt compound. 3405-HP is designed to be applied in situations of both new and re-serviced joints (expansion and contraction) in concrete pavement, as well as for cracks in asphaltic concrete surfaces. When properly heated and applied to surfaces, which have been cleaned of dirt, dust and debris, it offers excellent bonding, repeated weathering resiliency, compressive and expansive capabilities. This product is packaged in 55-pound cartons composed of two 27-pound easily transferable buns.

PROPERTIES

Penetration, mm/10	80
Resilience, %	63
Flow, cm	0.1
Bond Test, 50% Extension @ -20°F (-29°C)	Pass
Viscosity CPS @ 380°F (183°C)	2000
Wt. Per gallon, Lbs.	10
Wt. Per liter, Kg	1.20
Preferred Pouring Temperature	370°F(188°C)
Safe Melting Temperature	390°F(199°C)

SPECIFICATIONS

ASTM D 3405, ASTM D 1190, AASHTO M 301, AASHTO M 173, Fed. Spec SS-S-1401C, Fed. Spec SS-S-164

LM3405-HP Joint Sealant

DESCRIPTION

This hot pour sealant is a quality, hot applied, one component rubber asphalt compound. LM3405-HP project sealant specifically designed for colder climate regions and will provide similar bonding characteristics to the standard 3405 material when continually exposed to below freezing temperatures. This low modulus joint sealant is designed to be applied in situations of both new and re-serviced joints (expansion and contraction) in concrete pavement, as well as for cracks in asphaltic concrete surfaces. When properly heated and applied to surfaces, which have been cleaned of dirt, dust and debris, it offers excellent bonding, repeated weathering resiliency, compressive and expansive capabilities. This product is packaged in 55-pound cartons composed of two 27-pound easily transferable buns.

PROPERTIES

Penetration, mm/10	80
Resilience, %	68
Flow, cm	0.1
Bond Test, 50% Extension @ -20°F (-29°C)	Pass
Viscosity CPS @ 380°F (183°C)	2000
Wt. Per gallon, Lbs.	10
Wt. Per liter, Kg	1.20
Preferred Pouring Temperature	370°F(188°C)
Safe Melting Temperature	390°F(199°C)

SPECIFICATIONS

ASTM D 3405, ASTM D 1190, AASHTO M 301, AASHTO M 173, Fed. Spec SS-S-1401C, Fed. Spec SS-S-164

1614JFR-HP Joint Sealant

DESCRIPTION

This hot pour sealant is a quality, hot applied, one component polymeric compound. 1614JFR-HP is designed to be applied in situations of both new and re-serviced joints (expansion and contraction) in concrete pavement that are subjected to fuel drips and/or leaks. When properly heated and applied to surfaces, which have been cleaned of dirt, dust and debris, it offers excellent bonding, repeated weathering resiliency, compressive and expansive capabilities. This product is not compatible with asphaltic paving materials and should not be applied directly over asphalt fiber expansion joint materials. 1614JFR-HP is supplied as a liquid in five-gallon (18.93 liter) pails at a weight of 9.9 pounds per gallon (1.2kg per liter). The recommended kettle heating temperature is 270°F (132°C) with a pour temperature of 250°F (121°C).



TESTING RESULTS

Penetration, Non-immersed @ 77°F (25°C)	11.0mm
Penetration, Fuel-immersed @ 77°F (25°C)	11.0mm
Flow, 72 Hours @ 158°F (70°C)	None
Bond, @ OF, three cycles, 50% extension	Pass 3 Cycles
Bond, Non-immersed	Without cracks or separation
Bond, Water-immersed	Without cracks or separation
Bond, Fuel-immersed	No deeper than 0.25m

SPECIFICATIONS

ASTM D 1854, ASTM D 3581, Fed. Spec. SS-S-1614A, Type II, Class 2, Fed. Spec. SS-S-167(b), AASHTO M-282, FAA-P 605 USE AND APPLICATION INSTRUCTIONS FOR HOT POUR JOINT SEALANTS

(All reference therein to asphaltic surfaces does not apply to DS Paving Products 1614JFR-HP).

- Sealing should be applied at atmospheric temperatures of 40°F (4°C) or greater. Joint sealant material is to be first melted in a double-jacketed melter-applicator that has an agitator, and temperature thermostats for both the oil compartment and the melting drum.
- FAILURE TO PROPERLY MELT, MAINTAIN DRUM HEAT AND AGITATION ACCORDING TO PROPERTIES OR APPLY AT PROPER ATMOSPHERIC TEMPERATURES AND/OR TO SURFACES WHICH ARE FROZEN OR WET WILL RESULT IN PREMATURE UNBONDING AND PERFORMANCE FAILURE AND ARE THEREFORE THE FULL RESPONSIBILITY OF THE PAVEMENT OWNER OR APPLICATION CONTRACTOR.
- Concrete Pavement: Joint configuration is a 2:1 ratio of a 1" (25mm) maximum width. Joint filler or backer rod should be initially placed at a proper depth below the concrete surface. Reservoir for sealant to be dry and clean for application of joint sealant material. Then properly apply sealant with the kettle manufacturer's recommended wand and nozzle so that the material fills the void flush with the pavement surface.
- Asphalt Pavement: Crack configuration is a 2:1 ratio of a 1" (25mm) maximum width. Reservoir for sealant to be dry

Joint Sealing Products - continued

and clean for application of joint sealant material. Properly apply sealant with the kettle manufacturer's recommended wand and nozzle so that the material fills the crack void from the bottom up. Overfill the crack and follow with a leveling tool to create an overlap level to the treated surface area approximately 3" (75mm) wide or slightly greater.

- Maintenance Re-Sealing: Re-servicing joints in both concrete and asphalt follow the previous defined procedures of material application except for the added initial first step of removing all old joint sealant due to earlier material applications to concrete expansion or contraction joints, or cracks in asphaltic surfaces. In the case of concrete, sawing with the proper cleaning blade is required — further sandblasting is preferred. Routing of pre-filled cracks in asphaltic surfaces is required. AGAIN PROCEED TO THEN INITIATE ALL STEPS FOR APPLICATION OF SEALANT TO NEW CONCRETE JOINTS OR ASPHALTIC CRACKS AS PREVIOUSLY ENUMERATED.

Elastomeric Seals

PROFILE

The main purpose of any concrete pavement compression seal is to keep water and debris from entering the joint. By doing so, it reduces the opportunity for pavement to crack, spall or chip at the joints.

There are many concrete joint seal products available today, but each has its disadvantages. Hot pour asphalt doesn't age well. Silicone caulk is costly because of its shorter functioning life. Joints sealed with silicone have to be replaced more often. Elastomeric Seals are extruded from special compounds of neoprene (poly-chloroprene).

Our seals remain in contact with the joint walls allowing pavement expansion and contraction throughout the harshest of temperature fluctuations.

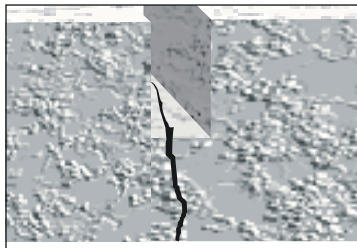

EASY INSTALLATION

In all instances, the joint sides must be reasonably clean and free of spalls with a properly designed width.

The most desirable installation temperature on jobsite is at 70° — 85°F (seals become more difficult to install at higher temperatures due to smaller joint openings) to as low as 35° — 40°F (the lubricant/ adhesives have impaired effectiveness in cold temperatures).

Pavement Seals

Our "E" and "V" series seals are the primary sealing system for concrete pavement slabs in highways, airport aprons and runways. Seals offer these advantages:

- Availability to seal joints in concrete even when moisture is present
- Resistance to jet fuel and other chemicals
- Speed of installation
- Product cleanliness
- Ease of inspection
- Dramatic reduction in concrete joint spalling

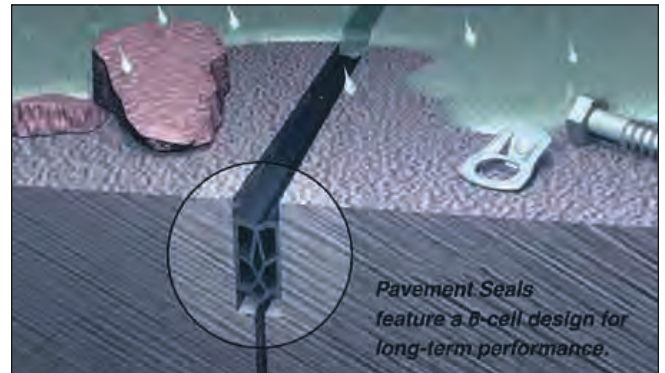

Seals effectively protect concrete pavement in highways, airport aprons and airport runways by keeping moisture, debris and incompressible material out of the joint opening.

Chart Notes:

- 1 Maximum movement which seal will accommodate in joint with correct design.
- 2 A narrower opening will place excessive stress on the seal and may cause premature failure.
- 3 A wider opening may not provide sufficient compressive force to hold the seal in place.

Meets ASTM D 2628 and AASHTO M-220 standard specifications. First number shown represents inches, metric dimensions (mm) are shown in parentheses.

Seal Catalog No.	SEAL CHARACTERISTICS			JOINT DESIGN CRITERIA		
	Nominal Width (W)	Nominal Height (H)	Max. Movement ¹	Narrowest Opening ² (A)	Widest Opening ³ (A)	Minimum Depth (B)
E-437	0.437 (11.11)	0.937 (23.81)	0.184 (4.67)	0.187 (4.75)	0.371 (9.42)	1.250 (31.75)
V-562	0.562 (14.29)	0.625 (15.88)	0.178 (4.52)	0.250 (6.35)	0.478 (12.14)	1.125 (28.58)
E-686	0.687 (17.46)	0.687 (17.46)	0.259 (6.58)	0.325 (8.26)	0.584 (14.83)	1.250 (31.75)
E-816	0.812 (20.64)	0.812 (20.64)	0.348 (8.84)	0.350 (8.89)	0.698 (17.73)	1.500 (38.10)
E-1006	1 (25.40)	1 (25.40)	0.450 (11.43)	0.400 (10.16)	0.850 (21.59)	1.750 (44.45)
E-1256	1.250 (31.75)	1 (25.40)	0.612 (15.54)	0.450 (11.43)	1.062 (26.97)	2 (50.80)
V-1625	1.625 (41.28)	1.125 (28.58)	0.781 (19.84)	0.600 (15.24)	1.381 (35.08)	2.375 (60.33)
E-2000	2 (50.80)	1.500 (38.10)	0.950 (24.13)	0.750 (19.05)	1.700 (43.18)	2.625 (66.68)
E-2500	2.500 (63.50)	2.500 (63.50)	1.100 (27.94)	0.775 (19.69)	2.125 (53.98)	4 (101.60)
E-3000	3 (76.20)	2.500 (63.50)	1.260 (32.00)	1.200 (30.48)	2.550 (64.77)	4.250 (107.95)

Typical joint design for the "E" and "V" series pavement seals

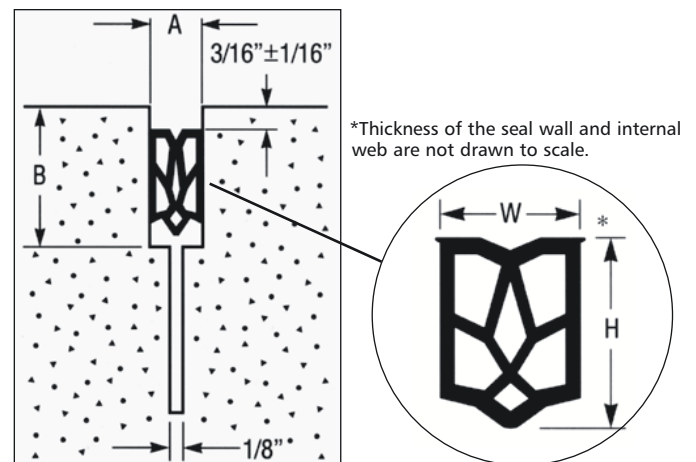



Lubricant Adhesive

ASTM D-2835 Specification

This product is primarily used with pavement seals. The function of this product allows the neoprene rubber seal to be easily inserted into the concrete void. This is particularly important, when the joint surface is rough, porous, and not completely clean.

Cat. I.D.	Part #	Description
L-85	150131	Lubricant Adhesive

E.A.J.A. ADHESIVE-4070

This product is a high quality adhesive used to bond bridge seal to steel faced armored joints. The audience is a one part moisture curing polyurethane and aromatic hydrocarbon solvent mixture. E.A.J.A.-4070 bonds neoprene bridge seals to concrete as well as iron surfaces. E.A.J.A.-4070 is the recommended adhesive for structural joint seals and strip seals.

Cat. I.D.	Part #	Description
L-85	150132	E.A.J.A.-4070 Joint Adhesive

**TECHNICAL DATA:
MEETS ASTM-D-2835 SPECIFICATIONS**

COLOR..... Amber
 Solid Content..... 25+/-1
 ASTM-D-814
 Viscosity 75 F ASTM-D-1084-63 7,000-7,500 cps.
 except HBF Brookfield No. 2 sp. 10 rpm
 Weight per gallon 8./20 minimum
 Drying Rate

FILM STRENGTH
 Tensile Strength 2.300PSI
 Elongation % Minimum..... 750%

COVERAGE
 7/16" TO 13/16" Seals 300L.F./Gal
 1-1/4" to 1-5/8" Seals 300L.F./Gal

SHIPPING
 Freight classification-Adhesive Cements NOIBIN Liquids

**TECHNICAL DATA:
MEETS ASTM-D-3542-82 SPECIFICATIONS**

Average weight per gallon
 ASTM-D-899..... 10.0+/-10%
 SolidsContent
 ASTM-D-898..... 72%+/-2%
 Adhesive will remain fluid between
 ASTM-D-412..... 5ûF+/-120ûF
 Elongation % Min 910%
 Color Amber
 Viscosity3400-4000 CPS
 1084
 Solvents..... N Methylpyrrolidine
 Amyl Acetate Aliphatic Hydro Carbons
 Flash PointASTM-D-92 45ûF

- ADVANTAGES:**
1. Single component eliminates variations in strength as opposed to two component mixtures.
 2. Moisture curing property eliminates the problem of humidity effecting the total curing of adhesives and coatings which are dependent on the molecular weight of the system after it cures.
 3. High solids content.
 4. Elongation above 910%
 5. Acts as an additional waterproofing membrane.

COVERAGE:
 Seals from 1 5/8" to 2" 150 LF/Gallon
 Seals from 2 1/2" to 5" 100 LF/Gallon

PACKAGING:
 In one gallon cans and 5 gallon pails.

FREIGHT CLASSIFICATION:
 Adhesive cements. NOIBIN
 Flammable Liquid - Red Label No. 3. UN No. 1133